

INSTALLATION INSTRUCTIONS: SECEUROGUARD 1000/1001 RETRACTABLE GATES

IMPORTANT NOTES

Please read this instruction booklet carefully prior to carrying out any installation of the SeceuroGuard gates.

Ensure that the correct fixings are used for SeceuroGuard fitment. All fixing holes must be used.

Firstly ensure all the parts are present by separating all the pieces then ticking off against the relevant part below

PRODUCT

	<i>Standard</i>	<i>Hinge aside</i>	<i>Split sash</i>
Single fixed panel or floating sash	Sash	Sash fitted in frame	Split sash fixing side
	Top & bottom tracks	Top tracks	Split sash locking
			Top & bottom tracks
Bi-parting	Left hand sash	Left hand sash fitted in frame	Left hand sash fixing side
	Right hand sash	Right hand sash fitted in frame	Left hand sash locking side
	Top & bottom tracks	Top track	Right hand sash locking side
			Top & bottom tracks

All the standard small accessories are packed in a yellow jiffy bag which is attached to one of the sashes. On the outside of each accessory bag is a label detailing its contents.

RECOMMENDED TOOLS

- Electric drill and masonry bits (suitable for no. 12 screw & plug - 7mm drill bit)
- Mallet • 4mm Allen Key • Spirit level
- Pozidriver (No. 3) • Ratchet & Pozidriver bit (for use in places with restricted access)

NOTE: Additional tools may be required if sections of skirting boards or dado rails need to be removed.

COMMON DEDUCTIONS

- Top track length = Overall width - 5mm
- Fixed bottom track length = Overall width - 5mm
- Lock post and picket length = Overall height - 59mm
- Side fixing frame length = Overall height - 5mm

These deductions do not apply to hinge aside gates, please contact your supplier for further information.

FASTENERS:

12 x 2 1/2" screws and plugs are the recommended MINIMUM fasteners for use when fitting retractable gates. However, different fixings may be required depending upon the material of the walls that the gates are being fitted to.

For SeceuroGuard 1001, the heads of all fasteners, including the hexagonal drive fixing plate fasteners, must be spoilt after fitting to inhibit removal. This can easily be achieved by drilling out or filling in the cross/allen drive in the head of the screw.

1001 INSTALLATION CRITERIA

The validity of the LPCB certification is contingent upon each security gate being installed in accordance with the requirements of LPS 1175.

- | | |
|---|------------------------------|
| • Reveal or face installation | • All fixings heads spoiled: |
| • Min distance from edge of reveal 50mm | Masonry 2.5" x 12s |
| • Max distance from any corner 100mm | Wood 4.0" x 12s |
| • Max distance between fixing 400mm | Steel 1.0" x M8s |

The silver label supplied, stating the manufacturer, the product, the security rating and the certificate number must be attached to the gate.

In addition to the installation criteria stated above the SeceuroGuard 1001 is also subject to the following restrictions:

Maximum Height	3000mm
Minimum Height	1000mm
Maximum Width (bi-parting)	Unlimited
Maximum Width (single sash)	Unlimited
Minimum Height (bi-parting)	500mm
Minimum Height (single sash)	400mm

SeceuroGuard 1001 is not available with the following options:
Hinge Aside, bottom running, removable bottom track.

INSTALLATION INSTRUCTIONS

THERE ARE TWO METHODS COMMONLY USED TO FIX GATES – BOTH ARE DETAILED. ENSURE THE DOME HEADED SIDE OF THE RIVETS ARE ON THE INTERNAL SIDE.

COMMON TO BOTH METHODS:

1. Measure reveal opening carefully and measure the overall

dimensions of the gate. Check if the dimensions of the gate are correct for the reveal size.

2. Remove any sections of skirting board or dado rails if necessary.
3. Ensure any handles (on windows or doors) or any other obstructions are clear of the opening.
4. Place the bottom track (**W**) in its correct position at the bottom of the reveal and leave loose until all the gate is in.

or

Slide the sash (or sashes) on the bottom track (**T**).

5. Assemble the gate and place it within the opening making sure that the sides are vertical and the top and bottom tracks are horizontal.

METHOD 1:

6. Once the gate is within the opening, open it out and mark ALL the fixing holes. Remove the gate from the reveal.
7. Drill & plug all fixing holes. The recommended fasteners for fixing the gates into masonry are 12 x 2 1/2" screws, although others fasteners may be used depending upon the material of the reveal.
8. Position the gate back into the reveal and fasten all fixings.

METHOD 2:

6. Once the gate is within the opening, open it out and separate the sashes from the fixing frame by removing the allen drive fasteners from the fixing plates that clamp the sash to the frame. Also separate the slam post from the fixing frame. To do this run down the join with a stanley knife to separate paint finish.
7. Slide the sash to the centre and drill out and plug all fixing holes. Fasten all fixings. The recommended fasteners for fixing the gates into masonry are 12 x 2 1/2" screws, although other fasteners may be used depending upon the material of the reveal.
8. Position the gate back into the reveal and fasten all fixings.

AND COMMON TO BOTH METHODS:

9. Close the gate and test the locking mechanism operates correctly. If it does not, in order to increase the movement of the lock hooks some vertical adjustment of the slam post can be made after slackening the fasteners. Alternatively check that the hooks are vertically aligned.
10. If necessary seal around the edge of the fixing frame with Silicone sealant i.e. if there are any gaps caused by undulations in the walls. On 1001 gates these must not exceed 5mm.

ADDITIONAL NOTES

HINGE ASIDE:

Installation is essentially the same as for standard gates.

However, care should be taken to ensure that the top track fixings are very secure as these fixings bear more weight as the top track is unsupported by the fixing frame. Extra care should also be taken to ensure that the gate is fitted vertical and square within the reveal.

NOTE: Gates are usually top running i.e. supported on rollers at top.

If the side of a hinge aside gate is face fixed an additional 50 x 25mm steel box section is supplied attached to the gate for fixing. If the side of a hinge aside gate is reveal fixed an additional 55 x 30mm angle is supplied attached to the gate for fixing.

1. Rotate the sash on its hinge and mark out, ensuring the sash and fixing frame are raised as high as possible so that the bottom track is clear of the floor.
2. Drill and fasten the gate in the same way as a fixed gate frame gate
3. Line-up the sash with the top track (B)
4. Locate and fix the top track (A)
5. Repeat steps 1-3 if the gate is a double sash
6. Fold down the 'W' section bottom track and drill a 15mm hole into the floor or window sill to suit the brass inserts into which the metal dowel locates. To ensure the top of brass insert is flush with the surface the hole will require enlarging to 18mm for a depth of 3mm.
7. Adjust strike bolt to suit.

- **FITTERS TIP** - *If the gate springs out when closed and the strike bolt is fully back. Loosen the top track from the fixing frame (see page 7) slide back and adjust*
- *Slide a suitably sized wooden packer into the top track to assist with holding the joints in the top track together while fixing the top track. Once the top track has been fixed remove the wooden packer.*

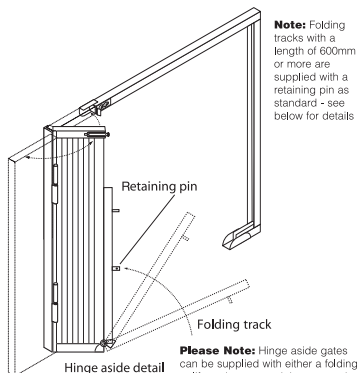

BOTTOM RUNNING

Before marking the position of the fixings for the fixing frame, the gate should be opened fully and the fixing frame height adjusted so that all the bottom wheels are in contact with the bottom track to evenly spread the weight.

FOLDING BOTTOM TRACKS

If the gate has a folding bottom track then a locating dowel and ferrule may be required and are supplied separately in the gate accessory pack. One dowel and ferrule is supplied per folding track.

The exact location of the dowel and ferrule is dependant on the surface the track will be resting upon but is generally towards the lift up end of the bottom track in either of the 'U' sections of the 'W' bottom track.

Bi-parting sash folding bottom track option

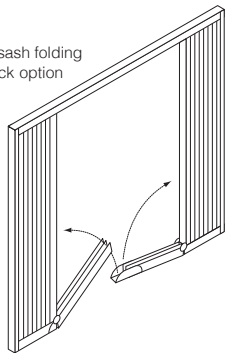

REMOVABLE BOTTOM TRACK

Both ends of the removable bottom track supplied will locate into the oversized 'U' channels attached to the fixed sections of the bottom track.

Removable bottom track option

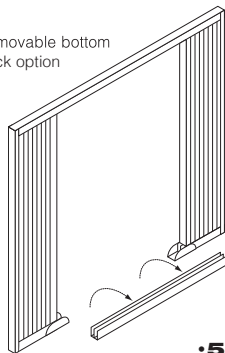

TERMINOLOGY

STANDARD GATES:

A = TOP TRACK

(SECTION:



DIMENSIONS : 40 x 40 x 12.5 x 2 mm)

B = FIXING FRAME

(SECTION:



DIMENSIONS : 45 x 20 x 15 x 2mm)

C = LOCK POST

D = SLAM POST

E = BOTTOM TRACK

(FIXED OR FOLDING/REMOVABLE)

F = DOWEL

G = FERRULE

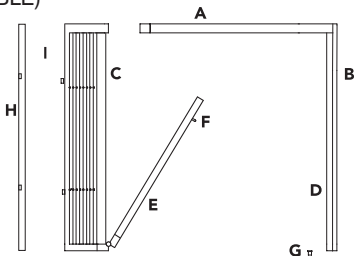
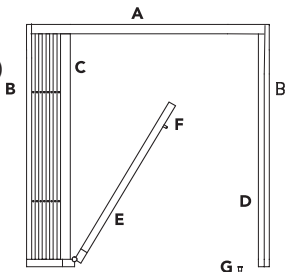

HINGE ASIDE GATES:

H = HINGE POST

I = GATE FRAME

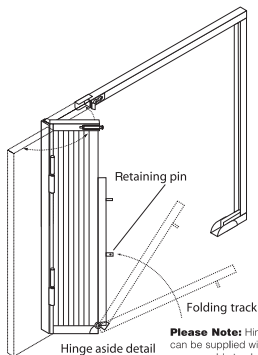

Note: Folding tracks with a length of 600mm or more are supplied with a retaining pin as standard - see below for details

Please Note: Hinge aside gates can be supplied with either a folding or removable track but cannot be supplied with a fixed bottom track.

TRACK PROFILES

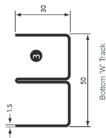
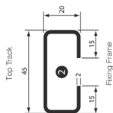
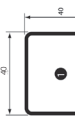

Lock Posts: Bottom "W" Track
Skinner/Guard 1000 only

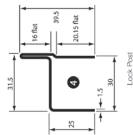

Lock Post



Picket

REVEAL FIXED
SIDE ELEVATION

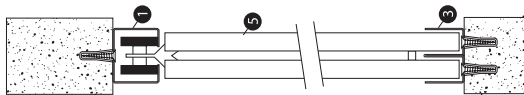

FACE FIXED SIDE
ELEVATION WITH PACKER

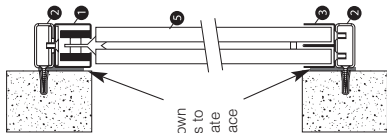

Face Fix shown
with packers to
accommodate
uneven surface

FACE FIXED
SIDE ELEVATION

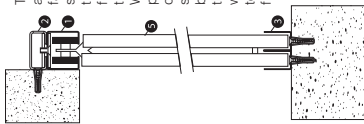

The standard arrangement for a face fitted gate is as shown with the top track and sides face fixed and the bottom track reveal fixed. When ordering please identify clearly how each side of the frame will be fitted. Importantly, the size of your order will be manufactured to a height including fixing frame(s).

FACE FIX PLAN VIEWS & FIXING DETAILS

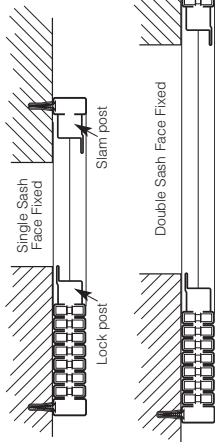

FIXING DETAIL FACE FIX



FIXING DETAIL

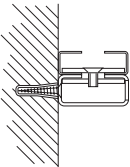

Face Fixed Side Frame Detail

REVEAL FIX PLAN VIEWS & FIXING DETAILS

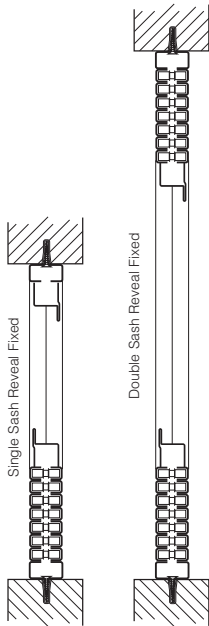

FIXING DETAIL

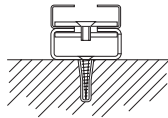

Reveal Fixed Side Frame Detail

SPLIT SASHES

All single sash gates wider than 2m and all gates wider than 4m will be supplied with split sashes which must be joined together during installation. The sashes will be supplied with the counter sunk plate's already in place and the pickets should be fastened together as shown.

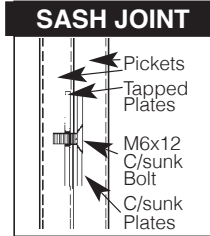

SPLIT TRACKS

Gates wider than 4m will be supplied with split top and bottom tracks. If the gate is bi-parting one section of track will be supplied slightly longer than the other to enable the centre stop to be located in the centre of the fully assembled track.

HANDLES FOR GATES

Handles for the gates, for easier opening and closing, are supplied as standard. The handles must be attached to a picket not the lock post. You must ensure the handle will not interfere with the operation of the lock or hit/interfere with the lattice. Rivets are supplied with the handle to attach it to the gate.

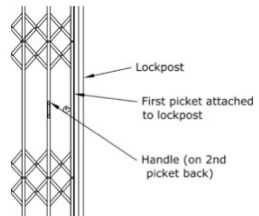

FLOATING SASH

If the gate has been supplied with a floating sash it should be installed in exactly the same way as a standard gate with the exception that there will be a set of lock and slam posts on both sides of the gate.

FIXED PANEL

If the gate supplied is a fixed panel it should be installed in exactly the same way as a standard gate with the exception that there will be no lock or slam posts.

PROBLEM SOLVING

1. Gate is stiff to open/close:
Lubricate the running wheels, nylon lattice bushes and the lattices rivets and run in by opening and closing the gate.
2. Gate fails to close properly:
This is caused by incorrect alignment of the lock post with the slam post. It is most easily corrected by slackening the fasteners that fix the slam post to the fixing frame (or sash if a double sash gate) and adjusting the slam post horizontally or vertically. Once the correct alignment is reached the fasteners should be tightened securely.
3. Key fails to turn in lock:
This can result from the ingress of the powder coating around the lock barrel. It can be simply overcome by lubricating the lock barrel, lock assembly and the locking hooks and by applying a firm force to turn the key. Also see point 9 on page 3.

COMMON DEDUCTIONS

The following deductions only apply to gates with a fixed bottom track.

Top track / bottom track length = overall width - 5mm

Picket length / lock post length = overall height - 59mm

Fixing frame length = overall height - 5mm

If the gate has a folding or removable bottom track or is hinge aside please contact your supplier if you have a query regarding the dimensions of the product supplied.

MAINTENANCE/OPERATING INSTRUCTIONS FOR RETRACTABLE GATES

OPERATION



BEFORE OPENING THE GATE, ENSURE THAT HANDS, CLOTHING ETC ARE CLEAR OF LATTICES TO AVOID TRAPPING

TO OPEN THE GATE:

Unlock the gate by turning the key through 360 degrees – hold the locking post up against the locking jamb if slight resistance is encountered.

Holding the gate by the locking post (or handle if fitted), slide the gate smoothly across until fully bunched. Repeat other sash if bi parting.

Wide gates may be more smoothly retracted by also pushing across from a point in the middle of the sash.

GATES WITH FOLDING TRACK

After retracting the gate, fold the hinged bottom track up against the bunch and hold in place using the pin and clip supplied.

GATES WITH HINGE ASIDE

Lift up the bottom track as above then, grasp the retracted sash by the locking post and pull firmly towards the body to disengage the catch at the top. The gate sash can now be carefully opened, clearing the reveal and into its final position.

GATES WITH REMOVABLE BOTTOM TRACK

After retracting the gate, carefully lift out the removable section and store.

TO CLOSE THE GATES

GATES WITH HINGE ASIDE

Swing the gate bunch back into the frame, pushing firmly to engage

the catch in the top track.

GATES WITH REMOVABLE OR FOLDING TRACKS

Restore the track, locating the pins on the underside of the track into the static part.

FOR ALL GATES

Holding the gate by the locking post (or handle if fitted), slide gate sash smoothly cross until a 'click' indicates that the locking posts have connected. Then lock the gate by turning the key through 360 degrees.

MAINTENANCE

The gates will benefit from regular cleaning and lubricating using WD40 or equivalent, paying particular attention to the lattice rivets and the wheels in the top track and wheels in the bottom track if the gate has been supplied with the bottom running option.

Externally fitted gates can be washed with warm, soapy water to remove dirt/grit.

Make sure that no foreign objects collect in the top or bottom tracks or become trapped in the lattice.

Take care when removing any items to avoid danger of trapping hands.

CAREFUL USE OF RETRACTABLE GATES IS THE BEST WAY TO AVOID MAINTENANCE OR REMEDIAL WORK